

# The Craftsman

COLLECTION

Quality Handcrafted in Pennsylvania, USA



# MISSION

As the Spanish swept across the southwest corner of North America they built furniture out of necessity. Today their simple style still resonates with seekers of simplicity and functional beauty. The sturdy lines of this revival style paired with the finest of American hardwoods complements the craftsmanship and comfort of Craftsman Collection Mission.

## MISSION OPTIONS

- Quarter-Sawn White Oak
- Brown Maple
- Red Oak
- Cherry
  
- Fabric
- Faux Leathers
- Genuine Leather

## MISSION FEATURES

- Handmade in America
- Durable Cushions
- Dovetail Drawer Boxes
- Full Extension Drawer Slides



and  
*comfort*  
of course!

# COFFEE TABLES & SOFA SERVERS

all pieces shown in oak with harvest stain

#01  
JR. COFFEE TABLE  
42" w x 18" d x 19" h



#13  
LIFT TOP COFFEE TABLE  
50" w x 24" d x 19" h



Shown in raised position (29").  
Features smooth acting lift mechanism  
made in the USA.

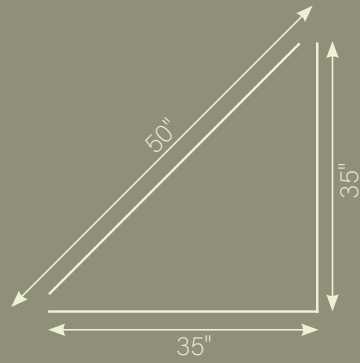

#12  
CORNER COFFEE TABLE  
19" high



#04  
SQUARE COFFEE TABLE  
34" w x 34" d x 19" h



#79  
SOFA SERVER  
14" w x 16" d x 24" h



#77  
LARGE SOFA SERVER  
20" w x 16" d x 27" h



#03  
COFFEE TABLE WITH DRAWER  
50" w x 24" d x 19" h



# MISSION

# MISSION END TABLES

all pieces shown in oak with harvest stain



#02  
JR. END TABLE  
22" w x 16" d x 25" h



#48  
ROUND END TABLE  
22" x 22" h



#07  
END TABLE WITH DRAWER  
24" w x 24" d x 25" h

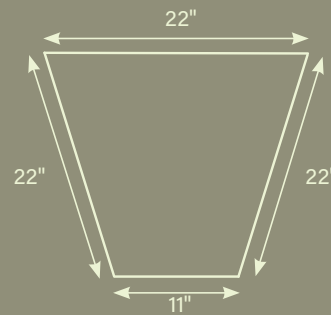

#11  
WEDGE TABLE  
22" w x 22" d x 25" h



#72  
END TABLE  
20" w x 23" d x 25" h



#05  
SQUARE END TABLE  
24" w x 24" d x 25" h



#06  
CHAIR-SIDE TABLE  
16" w x 22" d x 25" h



# MISSION

## SOFA TABLES & HALL FURNITURE

all pieces shown in oak with harvest stain



#98  
2 DRAWER SOFA TABLE  
50"w x 16"d x 30"h



#70  
HALL TABLE  
27"w x 14"d x 30"h



#99  
SOFA TABLE  
64"w x 16"d x 30"h



#20  
STORAGE BENCH  
42"w x 11"d x 19"h



#32  
DEACON'S BENCH WITH STORAGE  
47"w x 22"d x 45"h



#78  
CLOTHES TREE  
16"w x 16"d x 68"h

# MISSION

# ENTERTAINMENT

all pieces shown in oak with harvest stain



#91  
ENTERTAINMENT CENTER  
50" w x 19" d x 30" h



#90  
TV/VCR CABINET  
35" w x 19" d x 30" h  
with adjustable shelves



#68  
FUTON  
86" w x 37" d x 38" h



Back View



FUTON IN BED POSITION  
86" w x 54" d x 25" h  
MATTRESS  
54" w x 76" d x 10" h

## MATTRESS OPTIONS

Our futon mattresses are 9" thick and constructed of high quality foam and cotton. The mattress comes with a standard sage micro-fiber cover but is available in any of the colors below. The mattress can also be fitted with a fabric cover as seen in the pictures above. See page 57 for more fabric options



black blue chocolate sage tan



#09  
ENTERTAINMENT CENTER  
16" w x 44" d x 21" h



#93  
ENTERTAINMENT CENTER  
50" w x 19" d x 30" h  
with adjustable shelves

# MISSION



#85  
MISSION LOVESEAT  
60" w x 35" d x 37" h\*



#87  
OTTOMAN  
23" w x 16" d x 15" h



Back View

#84  
MORRIS CHAIR  
34" w x 35" d x 37" h\*  
shown in Rum leather



Morris chairs feature an 8 position recline.



Based on a design found in a small cabinetry shop in Sussex, England, the Morris Chair was developed and first sold by Morris and Company around 1866. Through the influence of Gustav Stickley and the American Arts and Crafts movement, the American Morris chair took on an unsophisticated air of sturdy reliability.

Our rendition of this faithful old chair features an eight position recline, gently curved armrests, and the same legacy of durable comfort.



#86  
SOFA  
86" w x 35" d x 37" h\*  
shown in 10-11 Myth fabric

\* all seats are approximately 19" high and 20" deep

# MISSION



#62  
**RECLINER LOVESEAT**  
58" w x 35" d x 42" h\*



#63  
**RECLINER SOFA**  
82" w x 35" d x 42" h\*  
shown in 16-52 Reap fabric



Wired/Wireless Powered Recline Controls



Padded Armrest Upgrade



Bustle Back Upgrade



#61  
**RECLINER**  
34" w x 35" d x 42" h\*  
shown in whiskey leather

From the legs to the last detail of the upholstery we take extra pleasure in creating exceptional recliners. The easy push-back mechanism is made in America and is built to handle all the wear that a comfortable recliner is prone to get. Each section of the loveseat and sofa recliners reclines independently.

Powered recliner upgrades come with a standard corded control that can be exchanged for cordless remote controls.

The Bustle Back upgrade option gives the recliner a soft cushion feel without losing its beauty.

# MISSION

\* all seats are approximately 19" high and 20" deep





#55  
**ROCKER**  
29" w x 36" d x 41" h\*



#53  
**SWIVEL GLIDER**  
31" w x 32" d x 42" h\*



Semi-Recline Position

#65  
**SWIVEL GLIDER RECLINER**  
31" w x 35" d x 41" h\*  
shown in cobblestone leather



#54  
**GLIDER OTTOMAN**  
23" w x 16" d x 15" h



#56  
**LIBRARY CHAIR**  
29" w x 27" d x 43" h\*



#52  
**GLIDER**  
31" w x 32" d x 42" h\*



Bustle Back Upgrade

We're serious about comfort. If you don't believe it try our swivel recliner. The mechanism is made right here in the United States. Paired with American hardwoods and premium upholstery that will resist the wear of everyday use. Add the bustle back upgrade for the next level of comfort!

# MISSION

\* all seats are approximately 19" high and 20" deep

# ZERO WALL

modular recliner system

#25, #27  
SINGLE RECLINER  
COMBINATION



#25, #27  
LOVE SEAT  
COMBINATION



Wired/Wireless Powered  
Recline Controls



Bustle Back Upgrade



#25, #27  
SOFA  
COMBINATION



#25  
ARM UNIT  
\*includes left & right arms



#26  
CORNER UNIT

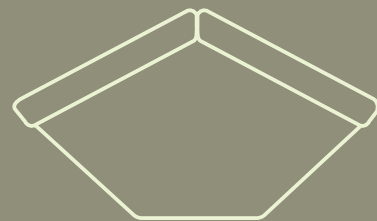

#27  
RECLINING SEAT UNIT

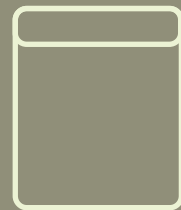

#28  
STATIONARY SEAT UNIT  
Non-reclining; looks exactly like #27

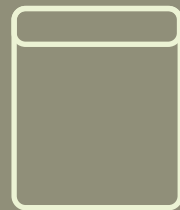

What will you create?

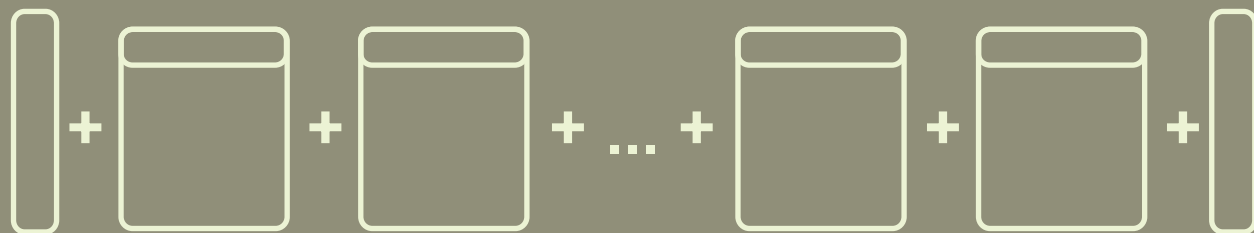

When we set out to create a wall hugger recliner we approached it with a no-holds barred attitude. This resulted in a recliner that is not only a true wall hugger but also totally modular, letting you create custom configurations that fit your needs.

The armrests, reclining seat, stationary seat, and corner unit connect securely using our special coupling system. Reclining units are functional no matter where they are located in the configuration. The ZeroWall modular system is available with power recline and bustle back upgrades.

# MISSION

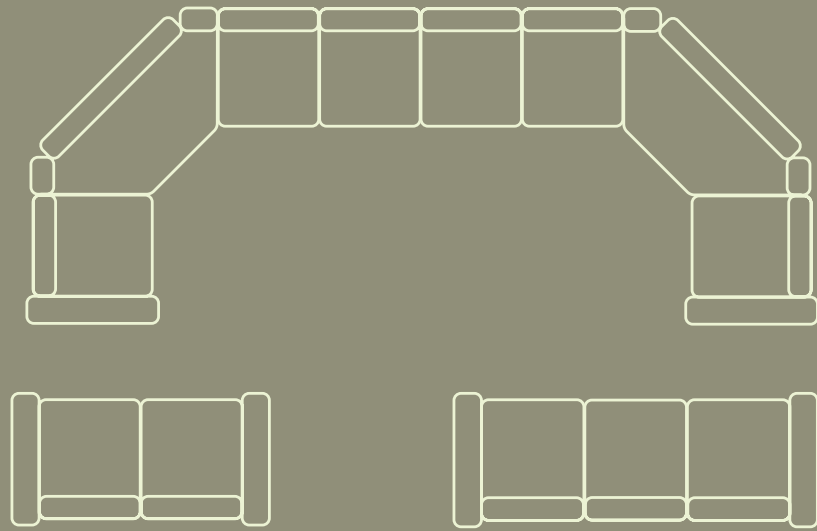

*What will you create?*

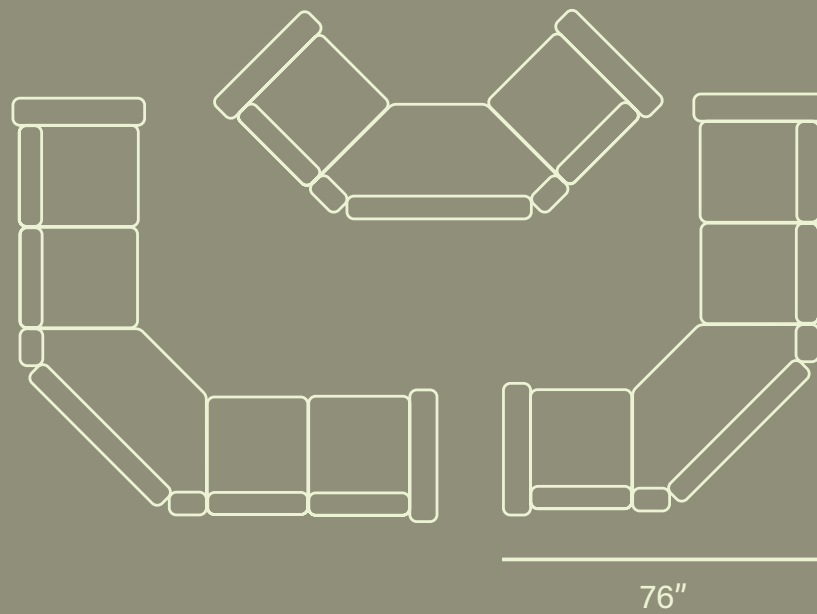

#16  
**RIGHT ARM UNIT**  
right and left arm units are sold as a set

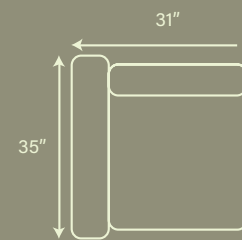

#17  
**MODULAR UNIT**

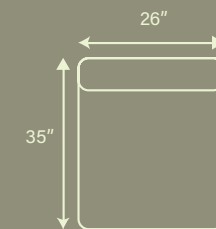

#15  
**CORNER UNIT**

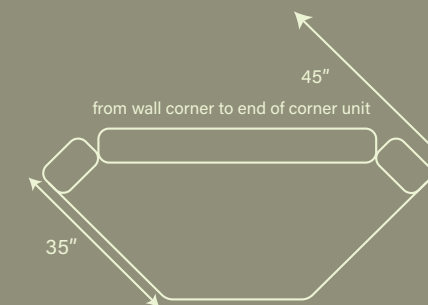

#16  
**LEFT ARM UNIT**  
right and left arm units are sold as a set

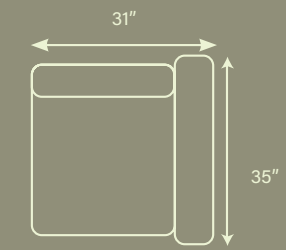

**Vari-LOC** Sectional Seating

The Vari-Loc sectional seating allows you to create multiple configurations from four simple base units. Each unit locks securely to the next to form a solid and seamless sectional sofa. And when it's time to move, your sectional will easily disassemble into manageable pieces.

**MISSION**

#58  
16" THROW PILLOW  
available in leather and fabric



#59  
20" THROW PILLOW  
available in leather and fabric



#81  
CLUB LOVESEAT  
57" w x 35" d x 30" h\*  
shown in Oak with  
Autumn Wheat stain



#82  
CLUB CHAIR  
36" w x 35" d x 30" h\*  
shown in Quarter-sawn White Oak  
with Michaels OCS 113 stain



#80  
CLUB SOFA  
78" w x 35" d x 30" h\*



Back View

This heritage take on the sofa is deeply rooted in mission style. The low profile makes the club a great option when you want to maintain an open feel or when placing it in front of a window. All fabric seat and back cushions come in one unit, as seen on the loveseat, unless special ordered. Leather cushions will be divided, two sections for loveseats, three sections for sofas.

# MISSION

\* all seats are approximately 19" high and 20" deep



# Santa Fe

With their clean, open silhouettes the Santa Fe occasional portray an exceptionally pure mission and pair well with our Classic Mission and Panel Mission upholstery.



#873  
SANTA FE COFFEE TABLE  
41" w x 19" d x 19" h\*



#877  
SANTA FE SOFA TABLE  
42" w x 16" d x 30" h\*



#876  
SANTA FE END TABLE  
18" w x 22" d x 22" h\*

#36  
FIREPLACE  
59" w x 14" d x 42" h\*  
with electric fireplace insert



Side View

Bring the comfortable glow of a fireplace into any room of your house without the need to vent or make permanent changes. The fireplace insert can be connected to a 110 volt wall outlet and provides electric heat and flame simulations all controlled with the handheld remote. The fireplace sides open to reveal a hidden bookshelf.

# MISSION

# CLASSIC MISSION

The petite spindles of the mission style give way to the wide slats, thick tops, and heavy legs of the Classic Mission style. The durable simplicity that's written all over this style promise a stable, comforting atmosphere.

## CLASSIC MISSION OPTIONS

- Quarter-Sawn White Oak
- Brown Maple
- Red Oak
- Cherry
  
- Fabric
- Faux Leathers
- Genuine Leather

## CLASSIC MISSION FEATURES

- Handmade in America
- 1" Thick Table Tops
- Durable Cushions
- Dovetail Drawer Boxes
- Full Extension Drawer Slides

and  
*comfort*  
of course!





#176  
CLASSIC END TABLE  
21" w x 25" d x 25" h

**MORE IN CLASSIC MISSION**  
Many of the items featured in pages 13 to 23 of this catalog are also available in classic mission. Here's just a few of them:

- 168 Futon
- 116 Sectional
- 182 Club Chair
- 181 Club Loveseat
- 180 Club Sofa
- 165 Swivel Recliner
- 154 Gliding Ottoman
- 127 ZeroWall Recliners



#155  
ROCKER  
29" w x 36" d x 41" h\*



#173  
COFFEE TABLE  
50" w x 25" d x 19" h



#177  
SOFA TABLE  
50" w x 16" d x 30" h



#156  
LIBRARY CHAIR  
29" w x 27" d x 43" h\*

\* all seats are approximately 19" high and 20" deep



CLASSIC MISSION



#161  
**RECLINER**  
34" w x 35" d x 42" h\*



#162  
**RECLINER LOVESEAT**  
58" w x 35" d x 42" h\*



#163  
**RECLINER SOFA**  
82" w x 35" d x 42" h\*



#153  
**SWIVEL GLIDER**  
31" w x 32" d x 42" h\*



#185  
**LOVESEAT**  
60" w x 35" d x 37" h\*

#187  
**OTTOMAN**  
23" w x 16" d x 15" h\*



#184  
**MORRIS CHAIR**  
34" w x 35" d x 37" h\*

#186  
**SOFA**  
86" w x 35" d x 37" h\*



\* all seats are approximately 19" high and 20" deep

\*See pages 13 to 23 for details on our upholstered items.

# CLASSIC MISSION



Elegant with a slightly aristocratic air Panel Mission is a refined mission style that displays the finest in American craftsmanship. The rail & stile side panel is a technique that the early masters, though they may not have used it, would surely have been proud of.

# PANEL MISSION

## PANEL MISSION OPTIONS

- Quarter-Sawn White Oak
- Brown Maple
- Red Oak
- Cherry
  
- Fabric
- Faux Leathers
- Genuine Leather

## PANEL MISSION FEATURES

- Handmade in America
- Rail & Stile Panels
- Durable Cushions
- Dovetail Drawer Boxes
- Full Extension Drawer Slides

and  
*comfort*  
of course!





#261  
**RECLINER**  
34" w x 35" d x 42" h\*



#287  
**OTTOMAN**  
23" w x 16" d x 15" h

#284  
**MORRIS CHAIR**  
34" w x 35" d x 37" h\*



#276  
**END TABLE**  
21" w x 25" d x 25" h



#263  
**RECLINER SOFA**  
82" w x 35" d x 42" h\*



#226  
**STORAGE OTTOMAN**  
36" w x 20" d x 18" h



See pages 13 to 23 for details on our upholstered items.

\* all seats are approximately 19" high and 20" deep

# PANEL MISSION

**MORE IN PANEL MISSION**

Many of the items featured in pages 13 to 23 of this catalog are also available in panel mission. Here's just a few of them:

- 268 Futon
- 216 Sectional
- 261 Recliner
- 254 Gliding Ottoman
- 256 Library Chair
- 227 ZeroWall Recliners



#253  
**SWIVEL GLIDER**  
31"w x 32"d x 42"h\*



#255  
**ROCKER**  
29"w x 36"d x 41"h\*



#285  
**LOVESEAT**  
60"w x 35"d x 37"h\*



#265  
**SWIVEL GLIDER RECLINER**  
31"w x 35"d x 41"h\*



#280  
**CLUB SOFA**  
78"w x 35"d x 30"h\*



\* all seats are approximately 19" high and 20" deep

PANEL MISSION

First designed by a religious sect nicknamed the Shakers this style has a petite feel thanks to the signature tapering of the legs. Like the Spanish before them the Shakers embraced simplicity and utility, values that we work hard to build into our Shaker style.

# s h a k e r

## SHAKER OPTIONS

- Quarter-Sawn White Oak
- Brown Maple
- Red Oak
- Cherry
  
- Fabric
- Faux Leathers
- Genuine Leather

## SHAKER FEATURES

- Handmade in America
- Rail & Stile Panels
- Durable Cushions
- Dovetail Drawer Boxes
- Full Extension Drawer Slides

and  
comfort  
of course!





#573  
COFFEE TABLE WITH DRAWER  
42"w x 18"d x 19"h



#513  
COFFEE TABLE WITH LIFT TOP  
44"w x 22"d x 19"h (29" raised)



#576  
END TABLE WITH DRAWER  
18"w x 24"d x 25"h



#509  
PETITE SOFA TABLE  
38"w x 12"d x 30"h



#578  
WRITING DESK  
48"w x 22"d x 30"h



#501  
PETITE COFFEE TABLE  
38"w x 16"d x 17"h



#502  
PETITE END TABLE  
16"w x 22"d x 22"h



#577  
SOFA TABLE WITH DRAWER  
42"w x 14"d x 30"h

shaker

**MORE IN SHAKER**

Many of the items featured in pages 13 to 23 of this catalog are also available in Shaker. Here's just a few of them:

- 568 Futon
- 516 Sectional
- 561 Recliner
- 586 Sofa
- 565 Swivel Recliner
- 554 Gliding Ottoman
- 556 Library Chair
- 527 ZeroWall Recliners



#587  
**OTTOMAN**  
23"w x 16"d x 15"h

#584  
**MORRIS CHAIR**  
32"w x 35"d x 37"h\*



#555  
**ROCKER**  
29"w x 36"d x 41"h\*



#553  
**SWIVEL GLIDER**  
31"w x 32"d x 42"h\*



#563  
**RECLINING SOFA**  
82"w x 35"d x 42"h\*



shaker

\* all seats are approximately 19" high and 20" deep

Sea vibes come naturally with this nautical mission style. It's as if the Spanish sea captains asked for their own twist to Spanish Revival mission. Right at home in your oceanfront cottage but an equally excellent way to bring a bit of the seashore right into your home. The sea is calling, who can resist...

#### MISSION OPTIONS

- Brown Maple
- Red Oak
- Cherry
  
- Fabric
- Faux Leathers
- Genuine Leather

#### MISSION FEATURES

- Handmade in America
- Durable Cushions
- Dovetail Drawer Boxes
- Full Extension Drawer Slides
- Flared Feet and Gentle Curves

# Breezy

- Point -



and  
comfort  
of course!



#776  
END TABLE  
18"w x 22"d x 23"h



#777  
SOFA TABLE  
42"w x 15"d x 30"h



#773  
COFFEE TABLE  
42"w x 19"d x 19"h\*



#772  
END TABLE  
19"w x 22"d x 23"h



#713  
COFFEE TABLE WITH LIFT TOP  
44"w x 22"d x 19"h (29" raised)

*Breezy*  
- Point -



**MORE IN BREEZY POINT**

Many of the items featured in pages 13 to 23 of this catalog are also available in Breezy Point. Here's just a few of them:

- 761 Recliner
- 762 Recliner Loveseat
- 765 Swivel Recliner
- 753 Swivel Glider
- 754 Gliding Ottoman
- 716 Sectional
- 727 ZeroWall Recliners



#787  
**OTTOMAN**  
23"w x 16"d x 15"h

#784  
**MORRIS CHAIR**  
34"w x 35"d x 37"h\*



#786  
**SOFA**  
85"w x 35"d x 37"h\*



#763  
**RECLINER SOFA**  
82"w x 35"d x 42"h\*



#785  
**LOVESEAT**  
56"w x 35"d x 37"h\*

*Breezy*  
- Point -

\* all seats are approximately 19" high and 20" deep

# Breezy

- Point -



#753  
SWIVEL GLIDER  
31"w x 32"d x 42"h\*

#754  
GLIDING OTTOMAN  
23"w x 16"d x 15"h\*

#762  
RECLINER LOVESEAT  
82"w x 35"d x 42"h\*



\* all seats are approximately 19" high and 20" deep

# Wood Species

Every piece of furniture is produced with sustainably harvested American hardwoods which means that every tree that is cut down has a replacement sapling that is growing, sequestering carbon, and releasing oxygen. Instead of deforesting, our lumbermen are pruning and refining our wonderful resource, the forest.

**R**ed Oak is a hardwood prized for its hardness. The grain pattern is large and often stains darker showing the character of the oak and making each item a unique masterpiece.

**M**aple has a tight grain pattern and finishes with a smooth, hard surface. It is the ideal choice when pairing with paints or gray based stains.

**C**herry's rich tones give a full bodied look to reddish stains. The grain pattern is similar to maple. Cherry stains often appear deeper and richer as they age.

**Q**uarter-Sawn White Oak can be identified by its unique ray flake grain. To create quarter-sawn wood, the log is first quartered and then cut perpendicular to the growth rings. This results in a very straight, fine-grained surface.

To make the most of that distinction, we use quad-linear posts for the legs of our upholstered mission furniture. Usually, a leg post is created from a 3"x3" board. But with that approach, only two sides of the leg display the uniqueness of the ray flake grain. To overcome this obstacle, we cut four triangular pieces from our quarter-sawn wood, then glue them together, producing a leg of incredible strength, but most importantly, a leg that displays the beauty of the ray flake grain on all four sides.



Quarter-Sawn Log



Quad-Linear Post

# Stains

## Oak



## Maple

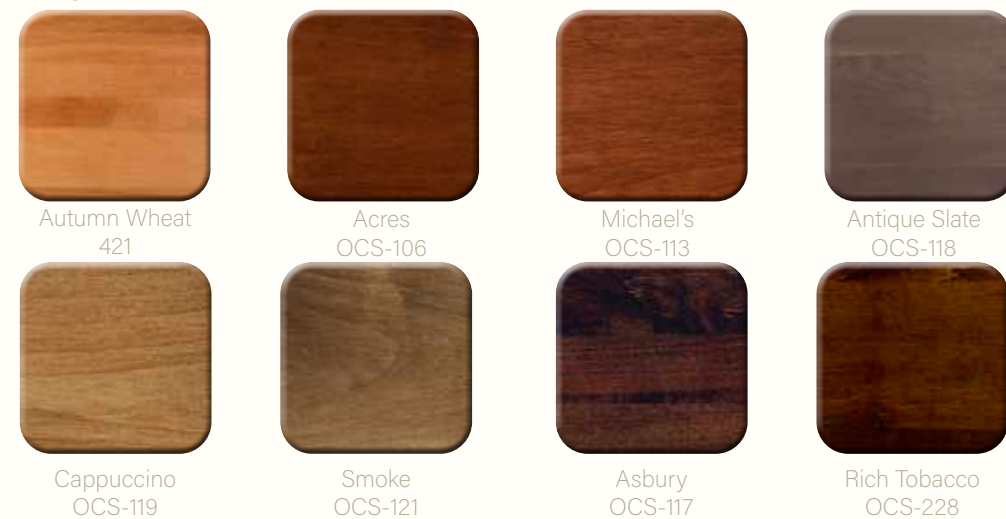

## Cherry



## Quarter-Sawn White Oak



a note about colors:  
Due to limitations in imaging and printing, some colors may not match exactly to what is shown here. For best results, make color choices from dealers sample blocks.

# DESIGN GALLERY

select colors and textures to make it truly your own

## Paint Colors

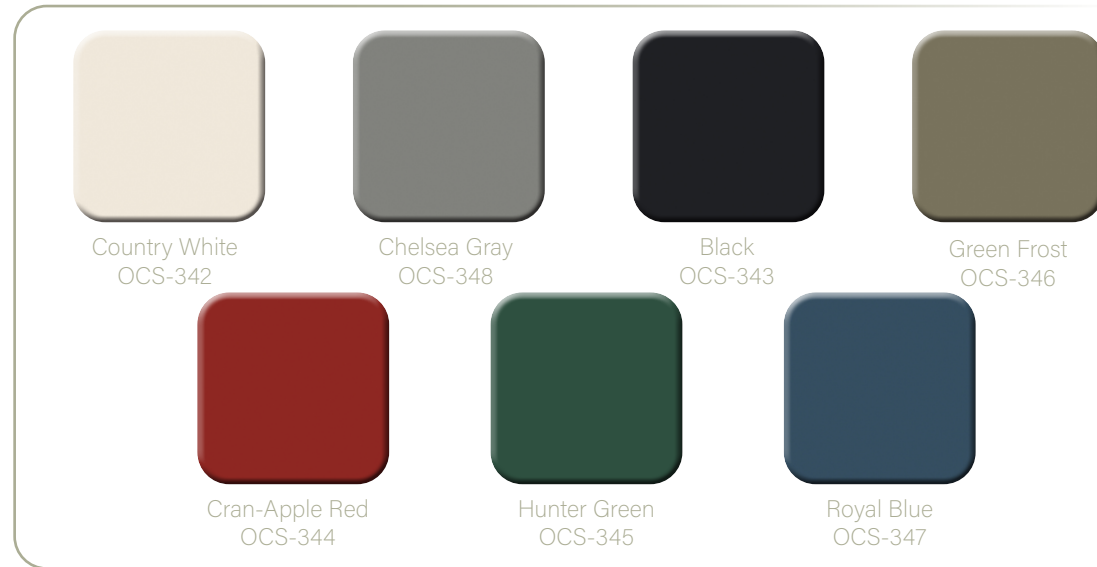

### Imagine The Possibilities!

Mix and match stain and paint colors to create your unique feel.

## Designer Finishes



### A note about colors:

Due to limitations in imaging and printing, some colors may not match exactly to what is shown here. For best results, make color choices from dealers sample blocks.

## Fabric Options

Many upholstery options are available. Ask us about our collection of 300+ choices of upholstery including Fabrics, Micro-fibers, Faux Leather and Genuine Leather by Heartland Fabrics. We also use Greenhouse Fabrics, Buckeye Fabrics, Sunbrella Fabrics, or COM (customer's own material).

## Popular Leather Choices



# DESIGN GALLERY

select colors and textures to make it truly your own

# Hardware

## Black



## Antique Brass & Oil Rubbed Bronze

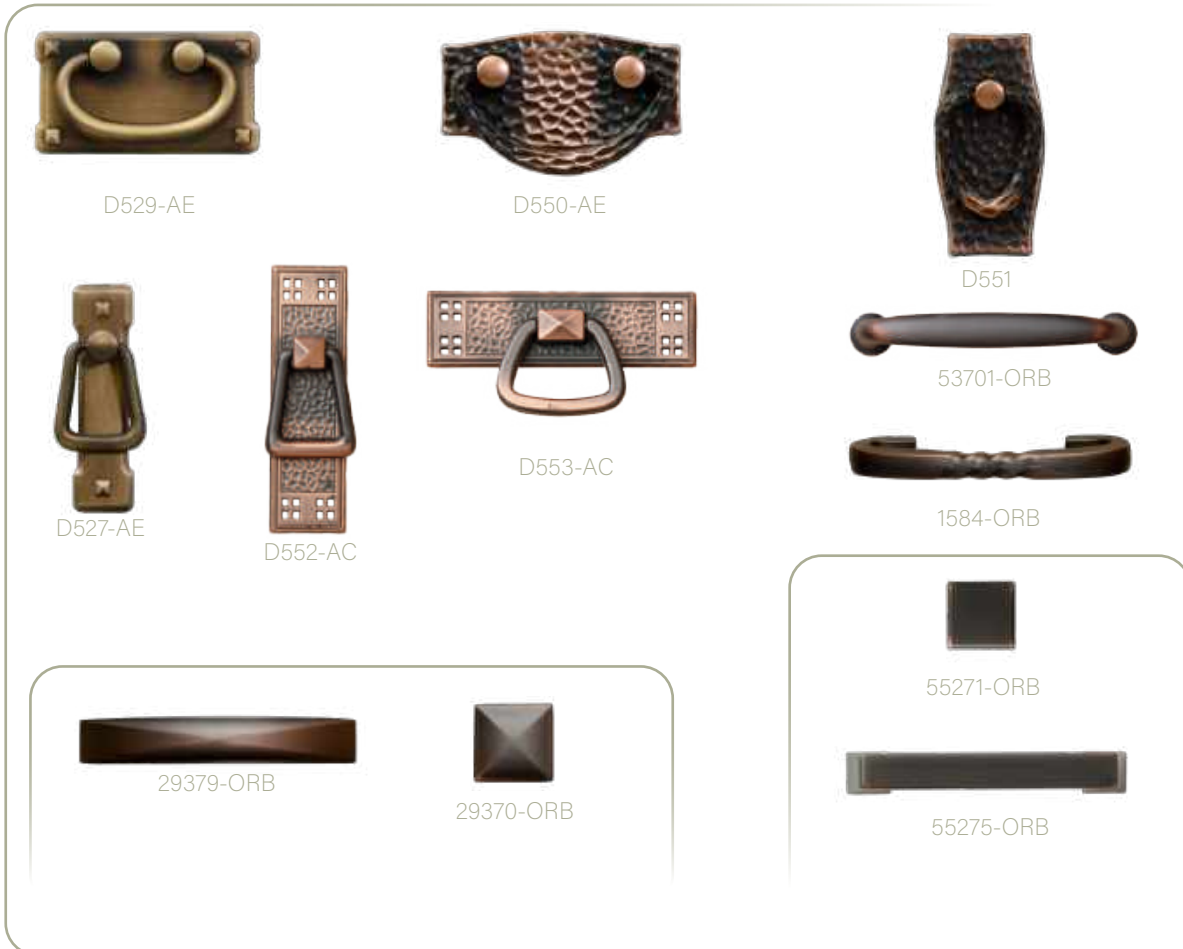

## Pewter & Gun Metal



## Silver



## Wooden



# DESIGN GALLERY

select colors and textures to make it truly your own

# GENERAL WARRANTY AND CARE

The Craftsman Collection warrants to you, the original retail purchaser, ten year protection against manufacturing defects of any wooden components. Defective parts will be repaired or replaced at our discretion.

Wood is a natural product, and although we take great care to match grain and colors, some variation may occur.

With some care your furniture will last for years! Keeping it dust free is very important. Use a soft towel dampened with water or a quality furniture polish to remove the dust. Do not use a silicone based furniture polish!

Natural wood will expand and contract with the seasons. This is normal, but it is important to avoid extremes in humidity and temperatures. Avoid having furniture in direct sunlight, close to heat sources, or in extremely damp or dry environments.

All warranties are void if the recommended care displayed above was not exercised.

## UPHOLSTERY WARRANTY

**Springs and Recliner Mechanisms:** The Craftsman Collection warrants to you, the original retail purchaser, ten year protection against manufacturing defects of the springs and recliner mechanisms. Electrical components of power recliners carry a two year warranty.

**Glider Bearings:** (250 lb. load rating) The Craftsman Collection warrants to you, the original retail purchaser, a three year warranty. If found to be defective, we will replace the defective bearing or bearings.

**Seat and Back Cushions:** The Craftsman Collection warrants to you, the original retail purchaser, ten year protection against manufacturing defects of seat and back cushions. Cushion warranty is for loss of cushion resiliency and not normal flattening and softening of cushions, which is a result of regular use and aging and should not be considered a manufacturing defect. If found defective, cushions will be replaced free of charge. After 2 years we will not be liable for freight.

Cushion softness is significantly affected by the type of fabric or leather that surrounds it. Where applicable, a rotation of the cushion will greatly extend the life of both the cushion and fabric.

**Fabric:** We offer a one year warranty against unusual wear of fabric under normal use and with proper care. This warranty does not cover fading, pilling, or crushing of fibers which can occur with the normal use of some fabrics. All claims within warranty will be submitted for industry testing. We will tender warranty only if it is determined to be an actual fabric defect.

**Genuine Leather:** We offer a three year warranty against unusual wear of leather under normal use and proper care. Genuine leather may be one of the most durable upholstery materials; however, even the best quality leather has flaws and natural markings. Our leather is a protected aniline dyed, top grain leather, making for easy cleanup. (A soft damp cloth is recommended.) However, body oils and dust, etc., will cause this leather to develop a natural patina as it is used, especially in light colored leathers. Slight variations of color, along with the above traits, are characteristic of genuine leathers and distinguish them from synthetic materials. If uniform color and consistent grain are required, a faux leather (vinyl) may be a better choice.

Any of the above warranties are void if it is determined that the furniture was abused, used by pets, or heavily soiled.

For more than 28 years we have been designing and building furniture for the Craftsman Collection brand. Currently we employ the fourth generation of family woodworkers.

Every piece of furniture is produced with sustainably harvested American hardwoods which means that every tree that is cut down has a replacement sapling that is growing, sequestering carbon, and releasing oxygen. Instead of deforesting, our lumbermen are pruning and refining our wonderful resource, the forest.

During the last 15 years we have added a large variety of motion and upholstered furniture. Today we are happy to say that 100% of our steel mechanisms are designed and manufactured in America. The foam cushions are made in North Carolina and then carefully upholstered in our own shops by highly skilled seamstresses and upholsterers.

For maximum control of quality our furniture is stained and coated with a conversion varnish in our own finishing facility. The finish products have been tested extensively and we are confident that they will preserve the wooden surface of your furniture for years.

With passion for good furniture and skilled craftsmen we feel confident that your furniture is built to last. That's the reason we offer our industry leading warranties.



